

BARCODE LABEL SCALE

SALES OPERATION MANUAL

Important Safety Information

1. Please read these safety instructions carefully.
2. For safety of SD card and USB data ,When pulling out SD or USB , please firstly press power button slightly for standby mode and then pull it out.
3. Keep this user manual for later reference.
4. Before turning on the machine, please make sure that the electric power meets the requirements, (such as the electrical pressure and frequency), and that your electrical outlet is really connected to the ground.
5. This product meets the relative requirements of the national standard IEC 60950:2001 “Safety of information technical equipment”.
6. Thunder can hurt this product and even your personal safety, so please pull out the network cable, electrical cable and other conductor connecting external attachment in thunder days.
7. The non-experts or non-authorized people please don't open the machine shell.
8. Please don't spatter any sundries or liquid into the machine; please don't stuff anything inside this product, otherwise it may cause short circuit and therefore may lead to fire or get an electric shock.
9. Please do not plug or unplug with wet hand.
10. Make sure the switch is off when plug or unplug the power.
11. Incorrectly changing the lithium battery on the main board and the UPS lithium battery in the machine may cause a blast, so please make sure installing and changing the lithium batteries under the instruction of the expert service personnel.
12. Please be sure not to change the battery with a wrong type one, otherwise there is danger of explosion. Be sure to deal with used battery with the way of dealing with waste battery.
13. Please charge the lithium battery about every three Months, in case it would discharge over time and lead to useless.
14. Please lay this product packed in the 10-40°C environment for at least 2 hours before turning on if it was stored in less than 10°C temperature environment during the transportation, so as to avoid the damage on the product due to a big change of environmental temperature.
15. For PLUGGABLE EQUIPMENT, the socket-outlet shall be installed near the equipment and shall be easily accessible.
16. Please don't throw anything on this product or hit against it.
17. Please do not disconnect the line cord while its working, if not the product would be broken.
18. Please be sure use our line cord only.
19. If there is abnormal noisy, burnt smell or smoke given out from the product, please cut off the power and disconnect the plug immediately. And contact the service center. Or there is danger of electric shock or fire.
20. Please do not allow children to climb up on the product, in case the product drops and hurt them.
21. Please do not disconnect any parts or lines except USB equipment while using.
22. Switch off the product if you will not use it in a long time.

1 SUMMARY

◆ Unique Function

- Support multiple connection methods for supermarket back-end data, can quickly connect with third-party supermarket back-end database via Web Service script. The headquarters can cooperate with cloud label scales to do the headquarters management branch data mode (Vanguard mode, Carrefour mode) via public network or VPN intranet by web66 (BS framework); single store can import data, connect database or automatically download data through LINK66; in addition, the third-party software can also be directly downloaded through connecting the dynamic library (YH mode).
- With cloud label scale function, it can be directly connected with B/S framework back-end.
- Originated insect-proof design (patented) in the world, which is able to prevent the machine from damaging insects, especially suitable for seafood department.
- Patented removable and renewable hot keypad (patented, 112*2 keys) design. PLU keys make it easy and quick to be operated, you don't need to memorize and input the serial commodity numbers, lest long queue in the shop. In addition, the hotkey can be edited via PC software at any time to meet your needs and printed out immediately.
- Optional linerless label printer module(LS4NXN), greatly saving cost and protecting environment when printing linerless label.
- Modularized printer design, easy to be replaced and maintain without professionals. (e.g. Printer module P-1,P-2,P-3)
- Each PLU barcode format and pricing unit can be selected in the scale, flexibly and easily to be used.
- Capable of printing batch serial barcode to carry out batch management of fresh commodity purchasing and the fresh status, this makes it possible to auto-set scheduling decrease price according to the fresh status when changing the price label, so as to avoid rotten once some of the commodity is neglected.
- World originated design based on the idea of POS network management. Exclusive offering PLU manage software, network manage software, label editing software, and 18-code barcode function, which brings fresh foods department to computer management, thus to solve the tough problem that long term exist in fresh commodity management.
- The first Barcode Label Scale compatible with label graphic edit software, which is able to adjust label dimension arrange from 30*30mm to 60*109mm that greatly cut down the label paper cost.

◆ Functions

- Barcode can be printed out vertically or horizontally.
- Print density can be adjusted according to sensitivity of label paper. Moreover, the auto voltage & temperature compensation design prolong the life time of printer 2-3 times.
- Capacity of installing larger label roll (1000 pieces labels)
- Supporting firmware online upgrade.
- Rapidly renew the hotkey according to actual usage requirements.
- Membrane Keyboard can be cleaned simply by wet cloth. High capacity of Anti-dirty.
- Support many languages' display and print, such as: English, Russian, Arabic, Portuguese and Spanish etc.
- Support one barcode multi-products of QR code, save lots of label paper, support to fast cashier and save customer queuing time.

◆ PLU Management

- Different barcode type can be selected for each PLU (e.g. EAN18, EAB8, etc)
- Price of PLU can be inputted temporary by scale keyboard during operation.
- Different Weight Unit can be selected freely for each PLU according to actual usage (e.g. 10g, 50g, 100g, 500g, kg, lb etc).

◆ Back Office Application

- Powerful capacity of logo design (Based on Windows system) allows users to design and download any Logo.
- Powerful capacity of PLU management (similar to Excel) makes the PLU Code, Name, Price and Description can be programmed easily.
- Parameter and Password can be set and download to scale through this Application, to control scale from back office.
- Providing technical file (.DLL) for easily connecting to POS system of supermarket.

- Can be connected to any back office application which based on different system, such as: NT, UNIX, Internet and so on.
- Different font can be selected for characters printed in label.

2 SPECIFICATION

Store display	64*384 LCD with backlight	65*132 with dot matrix LCD display	65*132 LCD with backlight	64*384 LCD with backlight
Customer display				None
Weighing range	6kg/15kg; 15kg/30kg			
Verification scale interval	2g/5g; 5g/10g			
Tare (Max.)	-5.998kg; -14.995kg			
Internal resolution	1/30,000			
Keyboard	112*2 PLU hotkeys			
Valid printing width	56mm			
Paper entry width	62mm			
Paper roll diameter	Max Φ 90mm (inner core ϕ 28mm); Max Φ 80.0mm(inner core ϕ 40mm)			
Print speed	120mm/s			
Label format	2/5 interleaved, EAN 128, EAN13, QR code, GS1, etc.			
Data storage	RAM: 2G, SD card			
Optional function	WIFI, linerless label printing			
COMM Interface	RJ45*1(Ethernet), RS232*1			

3 ACCESSORIES

- Main unit
- Display box
- Scale platter
- Quick start
- Blank hotkey sheet

4 DIMENSIONS

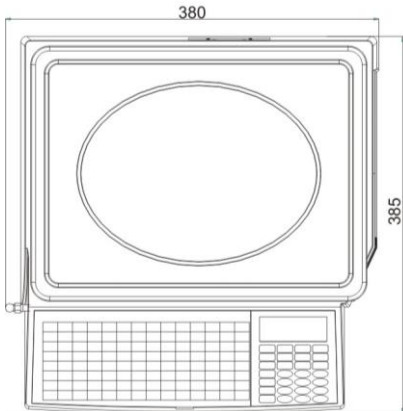
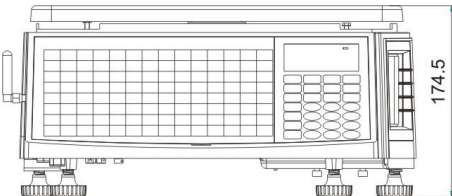
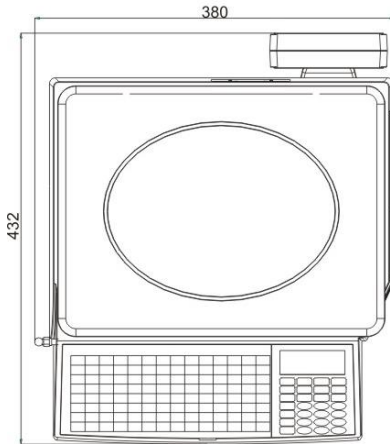
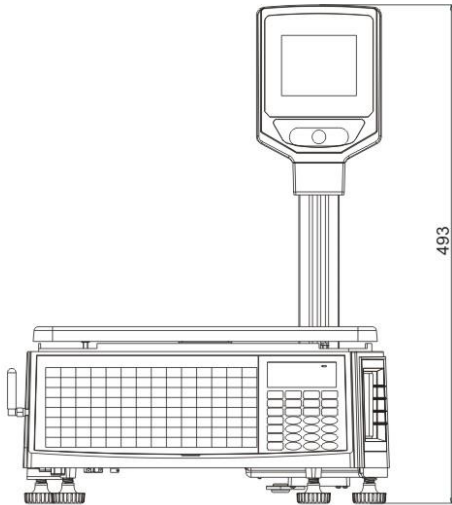

5 INSTALLATION

5.1 Install display pole

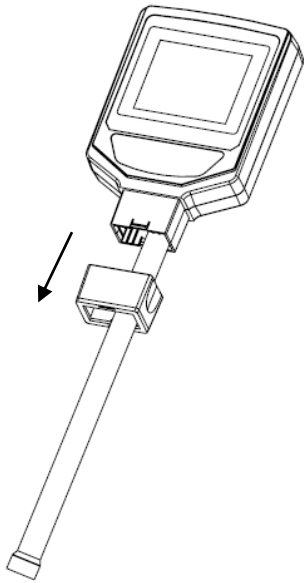

1. Take off the fix set.

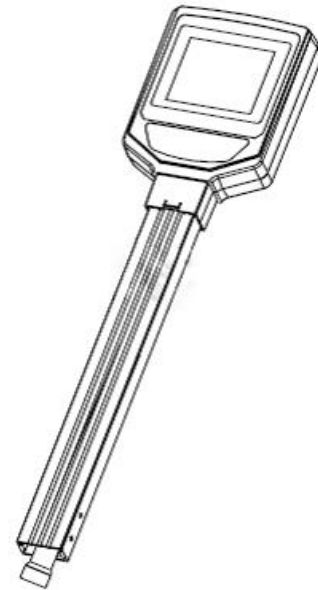

2. Mount the display pole.

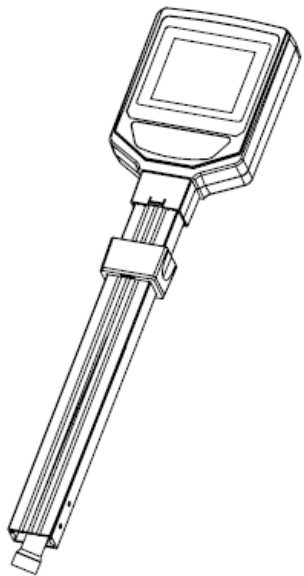

3. Put on fix set like the picture shows.

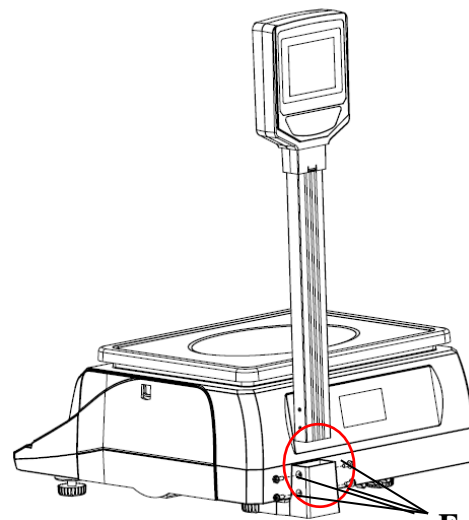

4. Put on fix set. Connect the line, and fix the 4 screws.

5.2 Hotkey sheet installation

Note: Please refer to “PC software management/Hotkey” downloaded from website.

Cut the hotkey sheet down and insert the hotkey sheet into the keyboard. Please take below pictures for your references:

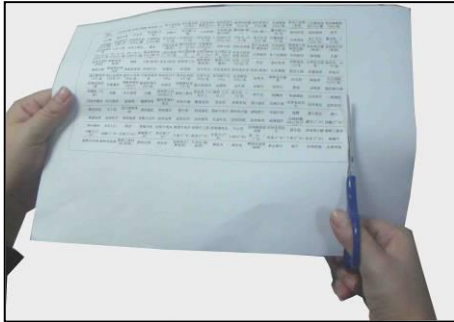

→ Cut the hotkey sheet down.

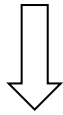

→ Push up the hotkey pad from bottom according to the arrow head.

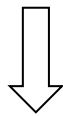

→ Insert the hotkey sheet into the hotkey pad.

5.3 Paper Installation

5.3.1 Label Paper Installation

Notice: please take the conveying protection bolt down, when you load the paper for the first time.

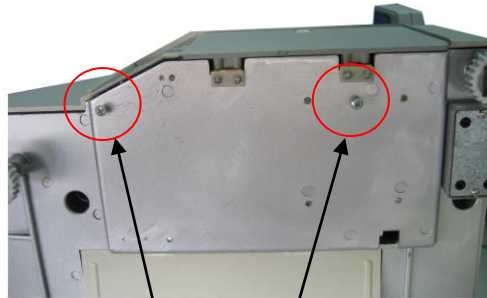

Conveying protection bolt



(1) Open the side cover

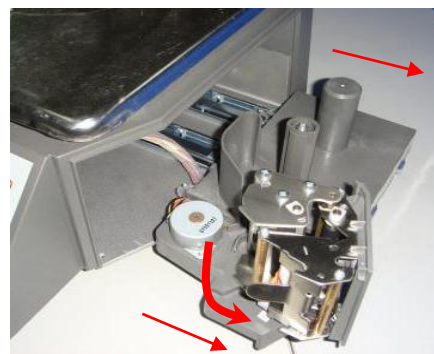

(2) Take out the printer, and open the turnable printing assembly



(3) Rip off the first several labels.

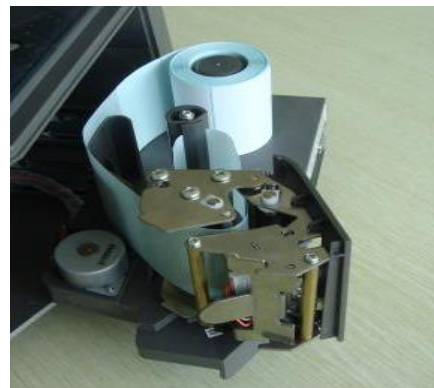

(4) Insert the release paper to the rewriter



Paper-fixing-block

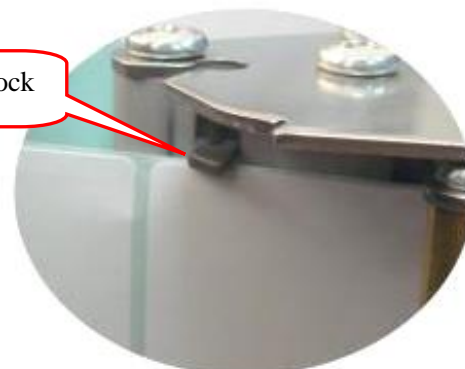

(5) Roll the release paper in the rewriter axis, and adjust the paper-fixing-block to fix the roll paper.



(6) Close the turnable printing assembly.



(7) Close the side cover

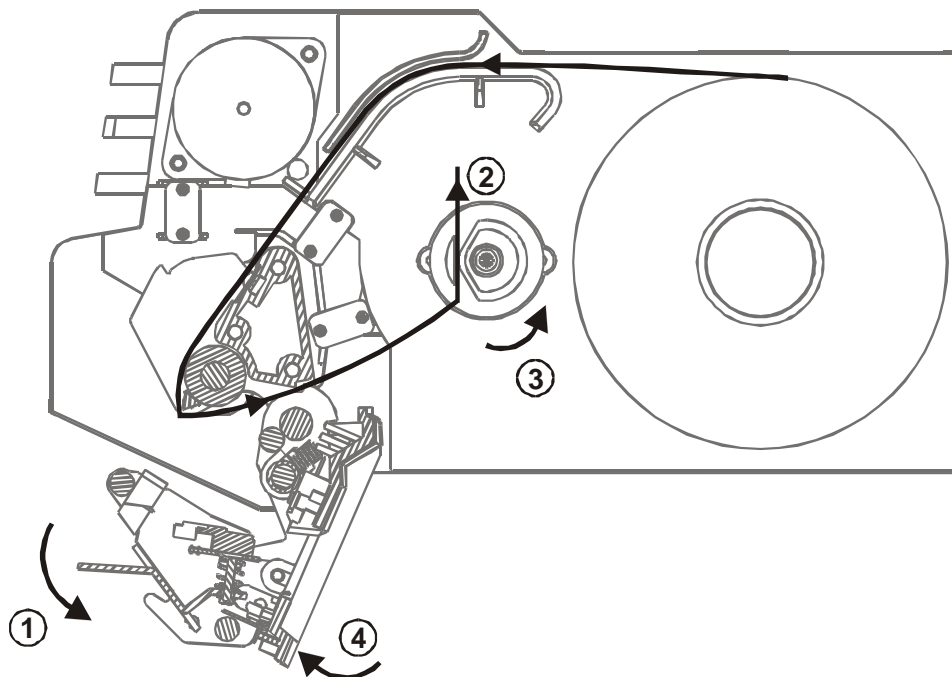

1. Turn the bar outwards, open the turnable printing assembly in the direction shown as the arrowhead ①.
2. Please rip off the first several labels, load paper in the direction shown as the arrowhead ②, and then roll the release paper in the re-winder axis as the direction of arrowhead ③ shows.
3. Push the turnable printing assembly to the right position in the direction shown as the arrowhead ④.
4. When every five-paper roll is used up, or the labels print unclearly, please clean the printing head by using cotton dipping cleaning oil or alcohol.

5.3.2 Receipt Paper Installation

1. Install the receipt paper-cutter.

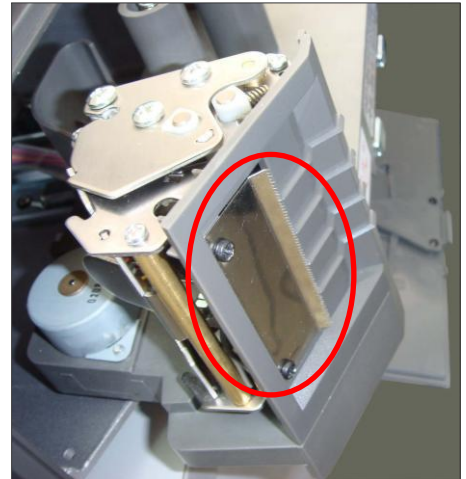

2. Open the turnable printing assembly.

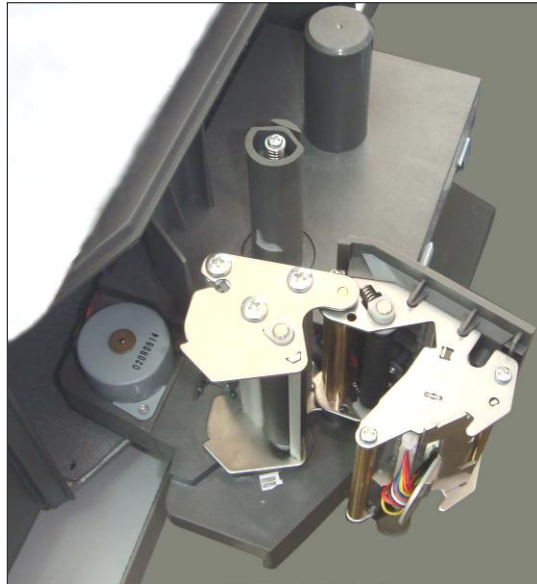

3. Load the paper like the map shows (directly lead the thermal paper to the paper outlet).

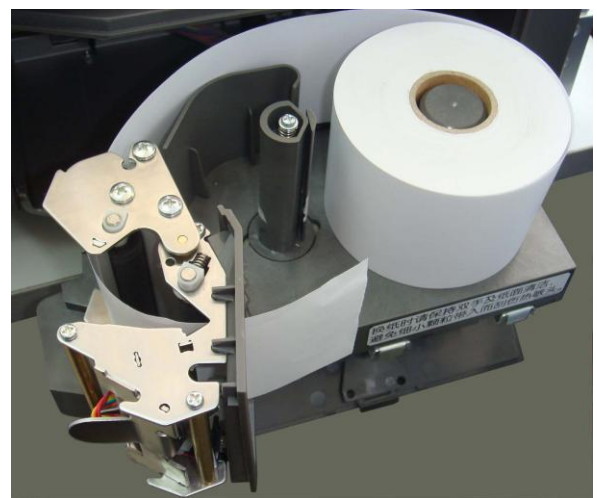

4. Pay attention to adjust the paper-fixing-block until the paper roll is fixed.

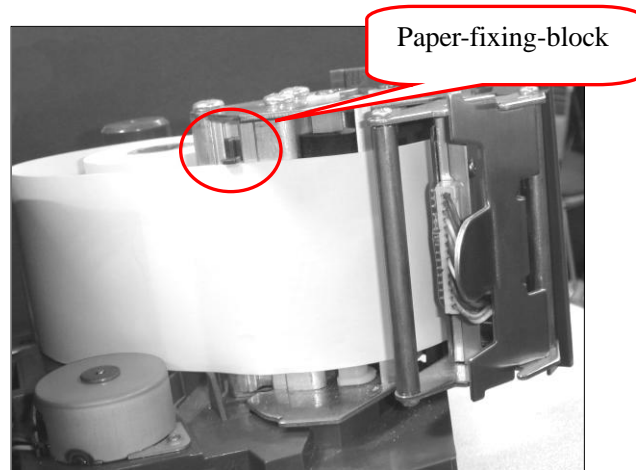

5. Close the turnable printing assembly.



6. Close the side cover.



NOTE: If you use thermal paper instead of label, you should choose 'RECEIPT' in 'System Set'. Please refer to chapter 9.2 'System set'.

5.4 Printer Replacement

If the printer is damaged, you can follow the steps below to replace a new one.

Precaution:

- Before you do the following operations, please cut the power supply first.
- Do not disassemble, assemble or adjust the printer if it is operating satisfactorily. In particular, do not carelessly loosen the screws holding various parts in place.
- When servicing, be sure not to leave used parts or screws, etc.

1. Demount the damaged printer



Open the printer cover.

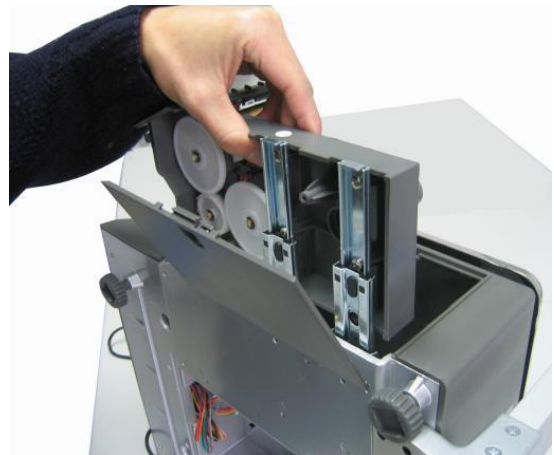

Pull out the printer

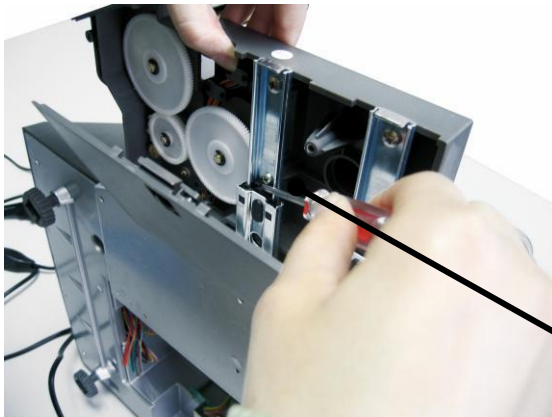

Use a screwdriver to push the latch to the left side.

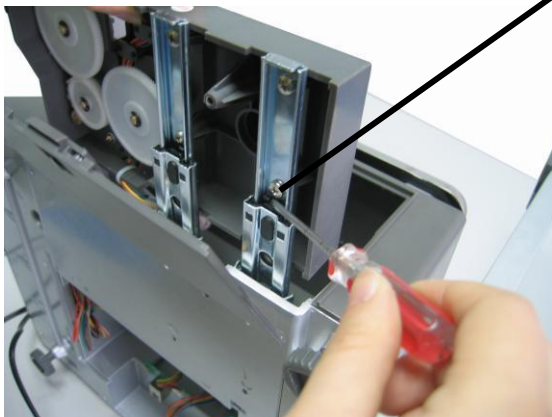



Lift up the printer

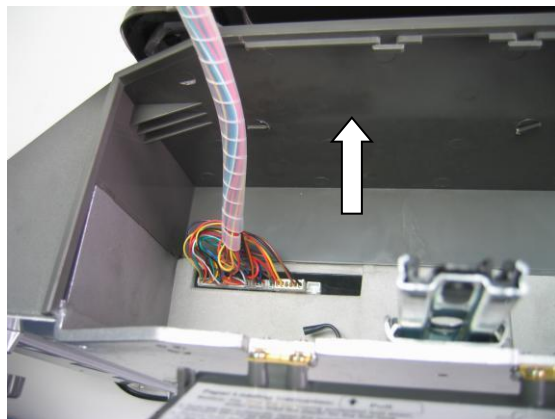
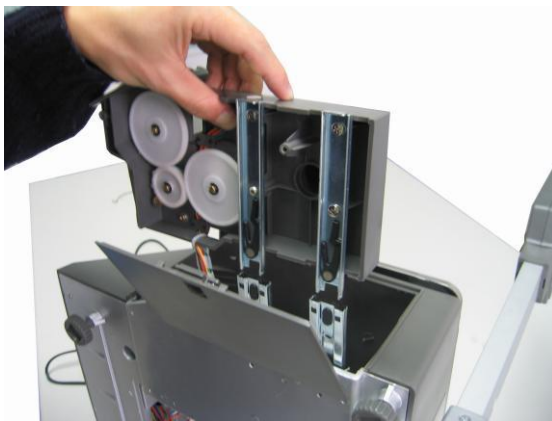

Pull out the cable

2. Install a new one

Install new printer by following the demount procedure in reverse order.

6 POWER ON/OFF

Hard power on

After plugged in, please press the Power Switch (location shows as below) to start the scale. Version number, date, IP address and count number '9, 8, 7...' for self-testing will be shown on the display. **Please wait and do not press any key, system initialization is going on.** Then the scale will enter to the sales mode.

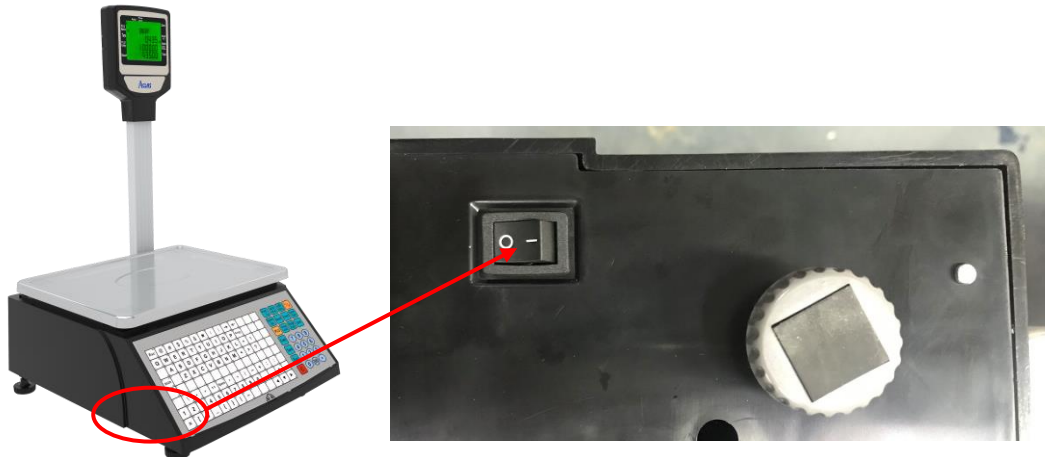

Soft power on/off







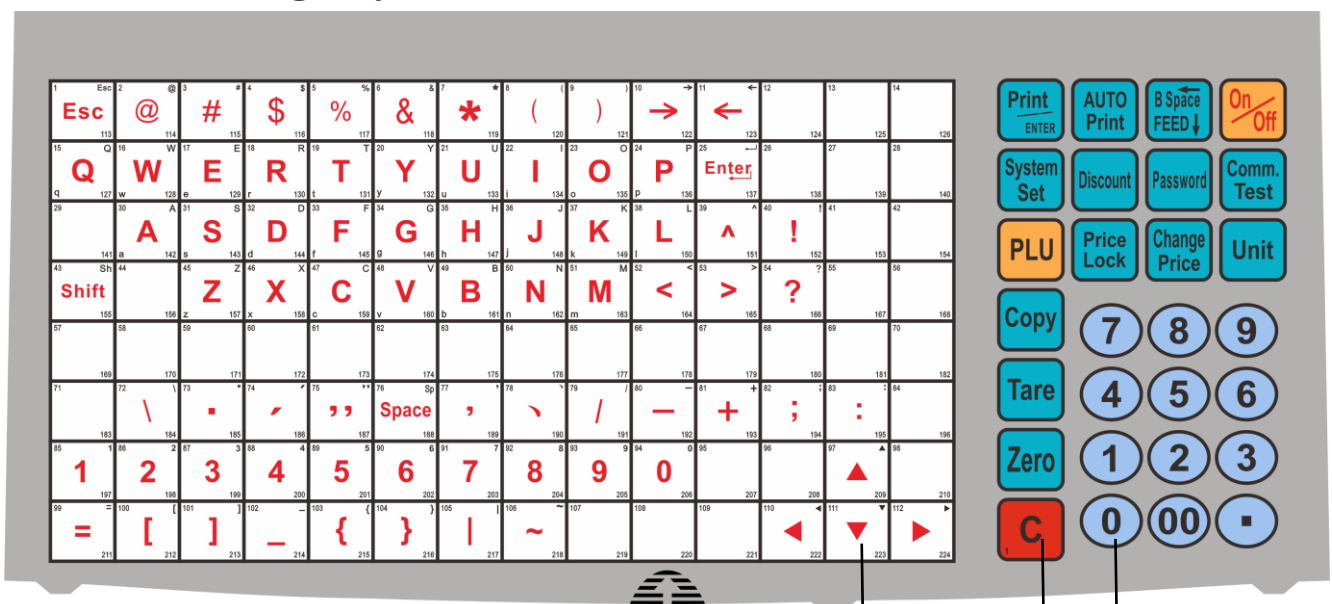

Press and hold the [On/Off] key for 2 seconds will achieve soft power on/off. If press the [On/Off] key to soft power on under the condition of soft power off, the display will show the IP address first and then enter to the sales mode.

Note: Please use [On/Off] key to turn off the scale, and do not pull out the power plug directly, especially if the scale is under the condition of connecting with network or downloading data.

7 General Using Key



- 1: Hotkey & keyboard
- 2: Function key
- 3: Number key

Name	Function	Operation	Note
	1. Usually use to clear unit price. 2. Clear abnormal picture or error information, and make the system back to normal state.	Press key 	
Comm. Test	Use to test whether the internet is normal	Press and hold this key until hearing a ‘beep’ sound, the display will prompts ‘NET OK’ if success.	
Auto Print	Automatically print label	Select auto print by press this key, and cancel the function by press again	It is on auto print condition when power-on, and press auto print key again to exit the function.
 B Space FEED 	Control the in/out of the paper; to place the labels; Input price or other information when do PLU edition, press this key can cancel the last operation.	One press can adjust the paper, long press will send out one paper and the scale will adjust the place of the label automatically	When meet the condition that do not send out labels or not completely send out labels during printing, long press this key to set the label again.
	This key is used to looking for the related item of the current field (hotkey 10, 11). Long press ‘system set’ to enter system set, and use these two keys to select the function you want to start or change.	Press  check last item, Press  check next item	
Price Lock	Price lock key. The price will clear when weight becomes 0, so press this key can avoid competing input the price when do weighing continuously.	Press  can weighing the same PLU continuously (PLU will not miss)	If you want to cancel this status, press this key again.

8 SALES OPERATION

8.1 Zero Operation

Please place the scale on the horizontal position and adjust the four level footstand to make the level bubble inside the small circle as the picture shows.



The weight can sometimes drift from zero due to debris on the platter, leaving objects on the platter for excessive periods of time, or other environmental factors. To correct this, remove everything from the platter and then press the [Zero] key to set initial zero.

8.2 Tare Operation

It is only applicable to the commodity packed in package or container such as eggs, beans or fruit and so on.

METHOD: Operation for commodity separated from container or package.

Trade example: A package of apples is sold. The hotkey of apples is 05, the net weight is 2.000kg and unit price is 6.000\$/kg.

OPERATION	KEY	DISPLAY			REMARK
		Weight	Unit price	Total	
1. Put the container or package weighing 1.000 kg on the pan.		1.000kg	0.00	0.00	
2. Press "Tare" key.	Tare	0.000kg	0.00	0.00	The "NET" signal means the scale is in the weight-deducting state.
3. Put a package of apples weighing 2.000kg on the pan.		2.000kg	0.00	0.00	
4. Press the hotkey 05 of apple through hotkey keyboard.	05	2.000kg	6.00	12.00	

5. Take away the container and the apples on the tray, then press “Tare” key.	<u>Tare</u>	0.000kg	0.00	0.00	This step is to leave the weight-deducting state. The arrow of “NET” disappears.
---	-------------	---------	------	------	--

8.3 Weight Unit Selection

1. Press and hold Unit key until hearing a long ‘beep’ sound.
2. Press Unit key to select the unit, and then press ENTER key to confirm or wait for a moment, the system will confirm the unit automatically.

8.4 Calculate by Weight

There are three kinds of operation. If PLU data is downloaded by background server PC or pre-edited in the scale, operation follows method 1 or 2. Otherwise the operation follows method 3.

Notes:

1. **AUTO state:** On the condition that the weight and the unit are nonzero and after the weight is steady, a label will be printed. When power on, “AUTO” signal is lighted, which means the scale is in “AUTO” state. Press “AUTO” key to switch off the state. Suggest making “AUTO” state as default state.
2. **ZERO state:** There is nothing on the pan. Press “ZERO” key to let the weight zero and the “ZERO” signal will be on.
3. **Usage of Print key:** All of the following operations including Calculate by Weight, Tare Operation, and Calculate by Piece, Discount, and Change Price are in the “Auto” state. If the default state is not “Auto” state, the Auto arrow on the LCD won’t be lightening, you must press Print key in order to print the label.

METHOD 1: Hotkey operation

Trade example: Some onions weighing 2.000kg are sold. Its hotkey is 01, and price is 0.500\$/kg.

OPERATION STEP	KEY	DISPLAY			REMARK
		Weight	Unit price	Total	
1. Press “Zero” key to let the scale return to zero	<u>Zero</u>	0.000kg	0.00	0.00	Ignore this step if the scale is in “Zero” status.
2. Put the onions 2.000kg on the pan.		2.000kg	0.00	0.00	
3. Press the hotkey 01 of the onions through hotkey	<u>0 1</u>	2.000kg	0.50	1.00	

NOTES:

- 1) There are 224 hotkey. These hotkeys can be changed randomly and be printed in a sheet quickly by the background PC.
- 2) The above operation is for the hotkeys from 1 to112. As to hotkeys from 113 to 224, the above operation step 3 should be changed as follows: Press “PLU” key and press the hotkey No. of the commodity. Other steps are the same.
- 3) All PLU hotkey could be edited and printed from the PC software.

METHOD 2: General operation

Trade example: Some onions weighing 2.000kg are sold. Their LFCODE is 10, unit price is 1.500\$/kg.

OPERATION STEP	KEY	DISPLAY	REMARK
----------------	-----	---------	--------

		Weight	Unit price	Total	
1. Press “Zero” key to make the scale return to zero.	<input type="text" value="Zero"/>	0.000kg	0.00	0.00	Ignore this step if the scale is in “Zero” status.
2. Put the onions weighing 2.000kg on the pan.		2.000kg	0.00	0.00	
3. Press “PLU” key	<input type="text" value="PLU"/>	LLFCODE? (1-6)			
4. Input LFCODE 10 of the onions through small keyboard.	<input type="text" value="1"/> <input type="text" value="0"/>	LLFCODE? (1-6)	10.00		
5. Press <input type="text" value="PLU"/> key.	<input type="text" value="PLU"/>	2.000kg	1.50	3.00	Ignore this step if the LFCODE has 6 digits.

METHOD 3: operation for PLU without settings.

OPERATION STEP	KEY	DISPLAY			REMARK
		Weight	Unit price	Total	
1. Press “Zero” key to make the scale return to zero state.	<input type="text" value="Zero"/>	0.000kg	0.00	0.00	Ignore this step if the scale is in “Zero” status.
2. Follow the steps in 7.3 Weight Unit Selection to select a correct price unit such as kg.	<input type="text" value="Unit"/>	0.000kg	0.00	0.00	
3. Input unit price 2.00 through the small keyboard.	<input type="text" value="2"/> <input type="text" value="0"/> <input type="text" value="0"/>	0.000kg	2.00	0.00	
4. Put on the commodity weighing 1.0kg.		1.000kg	2.00	2.00	
5. Press “Print” key	<input type="text" value="Print"/>	1.000kg	2.00	2.00	

8.5 Calculate by Piece

There are two kinds of operation methods. The following operation of method 1 and method 2 is suitable for PLU already downloaded by background sever or pre-edited on the scale.

Note: Before you taking these two operations, please make sure the PLU is pre-edited with piece calculation.

METHOD 1: Hotkey operation

Trade example: Ten pieces of cake are sold. The hotkey of cake is 05.

OPERATION	KEY	DISPLAY			REMARK
		Weight	Unit price	Total	
1. Input the number of the commodity through small keyboard. For example 10.	<input type="text" value="1"/> <input type="text" value="0"/>	0.000kg	0.10	0.00	

2. Press “Unit” key.	Unit	0.000kg	0.00	0.00	The LCD returns to initial state after “unit” key is pressed.
3. Press the corresponding hotkey 05 of the cake through PLU keyboard.	05	0.000kg	0.00	0.00	
4. Press “Print” key	Print	0.000kg	3.00	30.00	

METHOD 2: General operation

Trade example: Ten pieces of cakes are sold and the LFCODE of the cake is 12.

OPERATION	KEY	DISPLAY			REMARK
		Weight	Unit price	Total	
1. Input the number of the cake 10 through small keyboard.	1 0	0.000kg	0.10	0.10	
2. Long press “Unit” key and select a unit such as PCS (Kg).	Unit	KG 0.000kg	0.00	0.00	The unit of PLU should be PCS
3. Press “PLU” key.	PLU	LLFCOD ?			
4. Input LFCODE of the cake 12 through small keyboard.	1 2	LLFCOD ? (1-6)	12		
5. Press “PLU” key	PLU	0.000kg	3.00	30.00	Ignore this step if the LFCODE has 6 digits.

8.6 Discount

The scale supports two kinds of discount: % discount and total discount. This function can be locked by password which is set and can be randomly changed by background sever PC.

● % discount

Trade example: some peaches give a discount of 95. Its unit is 8.0\$/kg and hotkey is 12.

OPERATION	KEY	DISPLAY			REMARK
		weight	Unit price	Total	
1. Input discount proportion of the commodity 9 5 through numeric keyboard.	9 5	0.000kg	0.95	0.00	
2. Press Discount key.	Discount	0.000kg	0.00	0.00	The LCD returns to initial state after Discount key is pressed.
3. Put the commodity weighing 1.000kg on the pan.		1.000kg	0.00	0.00	
4. Key in the corresponding hotkey of the peaches e.g. 12.	12	1.000kg	8.00	7.60	

Notes:

As for step 3 and 4, please refer to the operation of ‘calculate by weight’. You can choose other kinds of operation such as normal operation or operation for pre-edited PLU to proceed with the above operation.

● **Total discount**

OPERATION	KEY	DISPLAY			REMARK
		Weight	Unit price	Total	
1. Long press the Discount key. Input the discount amount 1\$, and then press key ENTER .	Discount	0.000kg	0.00	0.00	The LCD returns to initial state after Discount key is pressed.
2. Put the commodity weighing 1.000kg on the pan.		1.000kg	8.00	8.00	
3. Key in the corresponding hotkey of the peaches e.g. 12.	12	1.000kg	7.00	7.00	

8.7 Change Price

Change the unit price of a commodity. There are two methods to change the unit price of a commodity, they are permanently change price and temporarily change price.

8.7.1 Permanently Change Price

METHOD 1:

Trade example: The unit price of the apples 4.000\$/kg. After changing price, its unit price is 3.000\$/kg and the hotkey is 05.

OPERATION	KEY	DISPLAY		
		Weight	Unit price	Total
1. Key the hotkey 05 of the apples via PLU keyboard.	05	0.000kg	4.00	4.00
2. Press Change price key.	Change Price	? PRICE?	0.00	4.00
3. Key in the new price 3.000\$/kg.	3 0 0	? PRICE?	3.00	4.00
4. Press Enter key.	Enter	0.000kg	3.00	0.00
5. Proceed with the normal operation of weighing or granular price calculating.				

METHOD 2:

Trade example: Some apples are sold. The unit price of the apple is 4.000\$/kg, and LFCODE is 900001. After change the unit price, the unit price of the apple is 3.000\$/kg.

OPERATION	KEY	DISAPLY
-----------	-----	---------

		Weight	Unit price	Total
1. Press Change price key.	Change Price	LLFCODE? (1-6)		
2. Key in the LFCODE 900001 of the apples through small keyboard.	900001	? PRICE?	0.00	
3. Key in the price changed 3.000.	3 0 0	? PRICE?	3.00	
4. Press Enter key.	Enter	0.000kg	3.00	0.00
5. Proceed with the normal operation of 'calculate by weight' or 'calculate by piece'.				

8.7.2 Temporarily Change Price

METHOD 1: temporarily change the price of cherry (its original price is 24.0\$/PCS(g)).

Trade Example: Sell 10 cases of the cherry, temporarily change the price as 30.0\$/PCS(g), and its hotkey is 11. When finish this dealing, it will recover to the original price 24.0\$/PCS(g).

OPERATION	KEY	DISAPPLY			REMARK
		Weight	Unit price	Total	
1. Key in 10 (10 cases) via the numeric key.	1 0	0.000kg	0.10	0.00	
2. Press Unit key.	Unit	0.000kg	0.00	0.00	Display is back to the initial status.
3. Long press the Change Price	Change Price	0.000kg	0.00	0.00	
3. Key in the hotkey	1 1	0.000kg	0.00	0.00	
3. key in the new price 30\$/PCS(g)	3 0 0 0	0.000kg	30.00	0.00	Begin with this step if sell the commodity by unit.
4. Press Enter key	Enter	0.000kg	30.00	300.00	

METHOD 2: Temporarily change the price of the PLU, which is needed to be weighted.

Trade Example: The unit price of the cabbages is 1\$/kg, and it should be change price as 2\$/PCS in the evening to promote it. When finish this dealing, it will recover to its initial price 1\$/kg.

Suppose a cabbage is 3kg, and its hotkey is 13.

OPERATION	KEY	DISAPPLY		
		Weight	Unit price	Total
1. Put the cabbage onto the scale.		3.000kg	0.00	0.00
2. Long press the key Change Price	Change Price	0.000kg	0.00	0.00

3. Input the LFCODE of PLU	<input type="text" value="1"/> <input type="text" value="3"/>	0.000kg	0.00	0.00
4. Key in the new price 2\$/PCS.	<input type="text" value="200"/>	3.000kg	2.00	6.00
5. Press <input type="text" value="Enter"/> key	<input type="text" value="Enter"/>	3.000kg	0.00	0.00

9 SOME SIMPLE OPERATION

9.1 Copy price label

1. Call PLU or input unit price in normal state and print a piece of label.
2. Press “Copy” key and input a number between 1 and 9, then press the <input type="text" value="Enter"/> key, the corresponding number pieces of label is printed.
3. Press <input type="text" value="Copy"/> key + <input type="text" value="0"/> key + <input type="text" value="Enter"/> key to print 10000 pieces of label continuously.
4. Press <input type="text" value="Copy"/> key and <input type="text" value="Enter"/> key to print 10000 pieces of label continuously.

9.2 Print receipt

1. Reloaded the rolling paper and extend its head out of the outlet. Make sure not roll the paper head in the rewinder.
2. Long press [System Set] key, use key [→] or [←] to select the [Hardware set]/[Paper] to set it as ‘RECEIPT’.
3. Press <input type="text" value="Enter"/> key to confirm.

Note:

If you want to use label paper again, you should enter this function to select the paper type as ‘LABEL’, and after setting you must restart the scale by press the on-off on the scale’s bottom (switch to ‘RECEIPT’ no need restart the scale).

9.3 Normal Package

This is suitable to quickly pack a same commodity (or different commodity with the same unit price) with different weight. (The **Package Type** is set as ‘Default’ on the scale software ‘PLU’.

1. Start up the function of “Auto” and “Price lock” (these two indicator light are lighting)	
2. Select PLU or input the unit price.	
3. Put the commodity (to be packed) on the pan and the label will be printed automatically.	
<p>Note: the operation of the right is suggested if you want to operate quickly.</p>	1. Put commodity 1 on the pan
	2. After the label is printed automatically put commodity 2 on the pan at the same time, take away commodity 1.
	3. Take away the label and stick it on commodity 1. The label of the commodity 2 will be printed out.
	4. Put commodity 3 on the pan and take away commodity 2.
	5. Take away the label and stick it on commodity 2, the next label will be printed.
	6. Repeat as the above steps to overlap the time of waiting for printing label and sticking label.

9.4 Package by Fixed weight

Fix weight package, this function is available by setting on PC software first.

For example: pack fish by the fixed weight 0.255kg, and the corresponding hotkey is 38.

Note: Before operate on the scale, please press key Price Lock first, and the indicator light for ‘price lock’ will be lighting.

OPERATION	KEY	Display		
		Weight	Unit Price	Total
1. Put the fish on the pan.		0.255kg	0.00	0.00
2. Press the hotkey 38 of the fish via PLU keyboard.	3 8	0.255kg	70.00	17.85

Attention: The commodity can be sold at the condition that its weight is between the weight tolerance +5%kg while it is in Fixed Weight package mode.

9.5 Package by Fixed Price

Fix price package, this function is available by setting on PC software first. (Choose the item ‘Fixed Price’ in the column ‘Package Type’, input the fixed price in the column ‘Unit Price’, and input the weight value for the commodity’s fixed price in the column ‘Package Weight’)

Note: 1. After download the setting data to the scale, the indicator light for ‘Fixed Price’ will be lighting;

2. Before operate on the scale, please press key Price Lock first, and the indicator light for ‘price lock’ will be lighting.

OPERATION	KEY	DISPLAY		
		Weight	Unit Price	Total
1. Put the fish on the pan.		0.505kg	0.00	0.00
2. Press the hotkey 38 of the fish via PLU keyboard.	3 8	0.505kg	0.00	35.35

Attention: The commodity can be sold at the condition that its total price is between the package tolerance \$+5% while it is in Fixed Price package mode.

10 FUNCTION SET

10.1 PLU Set

Notes: This operation can be locked by password that is set in background PC changed randomly.

◆ PLU Input

1. Press PLU key for 2 seconds. The display shows “LLFCODE?(1-6)”, it means the system is in the state of editing PLU.
2. Key in LFCODE and press Enter to confirm. Then the display shows “NAME” and press Enter key to enter PLU name editing status. Then, key in the PLU name needed, and press Enter key to confirm. You can use ← and → key to choose the item you want to edit, then press Enter key to enter the editing status.
3. After editing the information needed, use ← and → key to choose Save item, and then press Enter key to confirm.

After entering to the PLU edit interface, the details of PLU edit shows as below:

1) Input LFCODE number and press 'enter' key to confirm

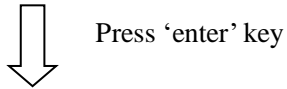

2) Input 'NAME' and press 'enter' key to confirm

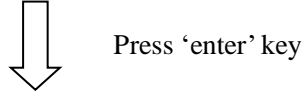

3) Input 'NAME 2' and press 'enter' key to confirm

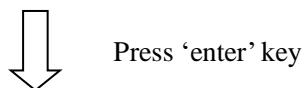

4) Input 'NAME 3' and press 'enter' key to confirm

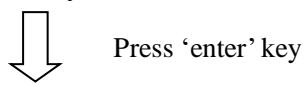

5) Input 'PLU CODE' and press 'enter' key to confirm

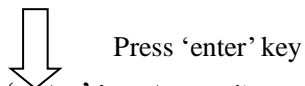

6) Input 'UNIT PRICE' and press 'enter' key to confirm

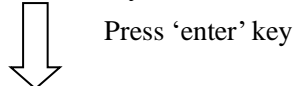

7) Input 'LIMIT MAX SALE PRICE' and press 'enter' key to confirm, you can switch digits by pressing numerical key '0'.

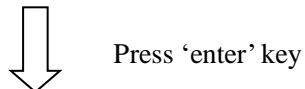

8) Input 'UNIT' of PLU and press 'enter' key to confirm (press '→←' key to select unit price such as kg, g, 100g, etc. press 'enter' key to confirm.).

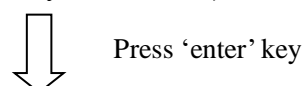

9) Choose 'TARE WEIGHT' mode (1 Normal. 2 Table) and press 'enter' key to confirm.

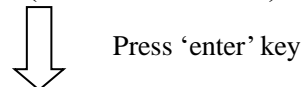

10) Input 'BARCODE', then press 'enter' key to confirm.

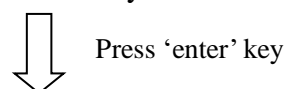

11) Input 'BARCODE2' and set barcode, then press 'enter' key to confirm.

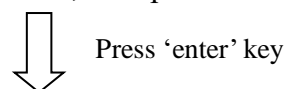

12) Input 'DEP (0-99)' number, then press 'enter' key to confirm.

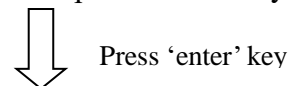

13) Input 'PACKAGE WEIGHT', then press 'enter' key to confirm.

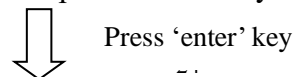

14) Use '→←' key choose 'PACKAGE TYPE' mode (1 Normal; 2 Fixweight; 3 Fix Price; 4 BOTH FIX) and press 'enter' key to confirm.

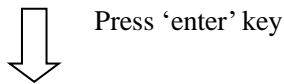

15) Input acceptable 'RANGE' and then press 'enter' key to confirm.

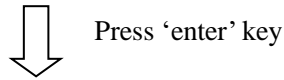

16) Input the information of 'LABEL 1 SELECT' and then press 'enter' to confirm.

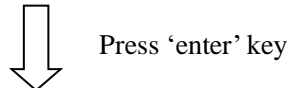

17) Set 'LABEL2 SELECT' number and press 'enter' to confirm.

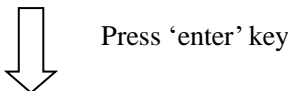

18) Set 'DISCOUNT' information, use '→←' key to choose discount mode (1 Normal, 2 Rate, 3 Table) and then press 'enter' to confirm.

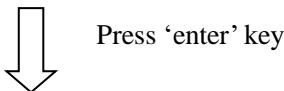

19) Set 'SHELF' and then press 'enter' key to confirm

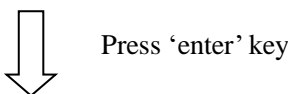

20) Input 'VALID DAYS' of PLU and then press 'enter' key to confirm

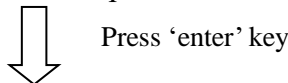

21) Input 'Group' number, then press 'enter' to confirm.

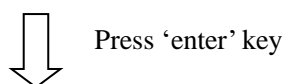

22) Input 'PRODUCTION DATE', then press 'enter' to confirm.

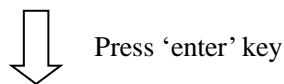

23) Input discount rate one by one when do the operation of 'DISCOUNT 1/2 PLU' or 'DISCOUNT 1/4 PLU', then press 'enter' to confirm.

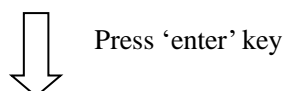

24) Set 'FLAG', to confirm whether the information of the PLU you edit will print out on the final label. (It contains 'product date/ pack time/shelf time/open price/shelf/valid (No: by days Yes; by hours)/valid time/ limit max sale price)

Egg: sale message? Select (1 YES; 2 NO), use '→←' to select YES or NO, and then press 'enter' to confirm. After finishing the deal, the 'sale message' will be print out on the PLU label. If

you want to enter the next item 'ingredients', press '→←' key.

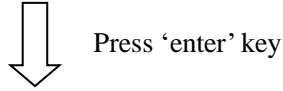

25) Input 'production date origin', then press 'enter' to confirm.

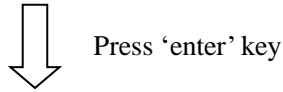

26) Input 'package date origin', then press 'enter' to confirm.

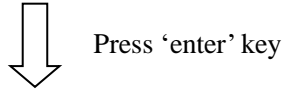

27) Input 'shelf date origin', then press 'enter' to confirm.

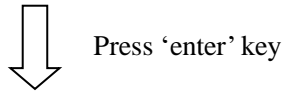

28) Input 'valid date origin', then press 'enter' to confirm.

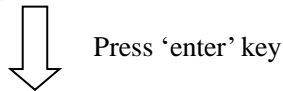

29) Input 'Hotkey' number, then press 'enter' to confirm.

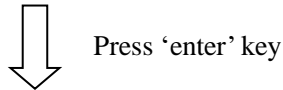

30) After edition, select 'save' (the edition information will be saved after this operation), and press 'enter' key to confirm, use '→←' key to find the save menu or use shortcut (hotkey 'S' on the right side) to choose the save menu.

After finishing the edition, back to the Label Editor, to make the label for the information you want to print out on the label and upload to the scale. Then, the sold PLU will be print out at the format of the label edit via LINK66. Check the PC software management for the details

◆ PLU Data Revise

The editing method of PLU data revise is the same as the method mentioned in the above chapter 'PLU Input'.

10.2 System Set

Note: This operation can be locked by password set in background PC server and is changeable as will.

1. Press the <u>System Set</u> for two seconds to enter the system setting state.
2. Use "←" "→" to select the desired items as follows: <u>SYSTEM SET/EDIT MENU/AD VALUE/REPORT</u> . Please refer to the following notes.
3. Press <u>Enter</u> key to confirm.

Notes:

1. SYSTEM SET: use key "←" "→" to select the desired items as follows:
 - 1) Hardware set: use key "←" "→" to select and set the LCD Contrast/Auto refurbish time/Date/Align/Label select (1-32)/Paper/Speed/Auto feed set/Print test page/LCD sleep

- time/Select second label (1-32)
- 2) Network set: use key “←” “→” to select and set Internet Protocol (TCP/IP) (includes Local IP address, subnet mark, default gateway, DNS server address source, preferred DNS server, Alternate DNS server, Local Port)/Server IP
 - 3) Parameter set: use key “←” “→” to select and set Print item in weight item/None weight can print/Handle tare/Pre tare/rebate to 23 department/Stat Warning?/Anti wind/Zero unit price print/default barcode set/currency place/decimal point in quantity column valid to single piece?/lock copy key/ EAN 13 code print first zero?
 - 4) Currency format: use key “←” “→” to select and set N.NN/N.NNN/N/N.N
 - 5) Continue print PLU: use key “←” “→” to select and set Start LLFCODE?(1-6)/End LLFCODE?(1-6)
 - 6) Amount format: use key “←” “→” to select and set T.TT/T.T/T.T0
 - 7) SYS Wei Unit: use key “←” “→” to select and set PCS kg/100g/kg/lb
 - 8) Round: set the round needed.
 - 9) Clerk: use key “←” “→” to select and set Clerk ID and password.
 - 10) Clerk modes: use key “←” “→” to select and set No clerk or Standard clerk
 - 11) Check: choose this item to enter into check mode.
2. EDIT MENU: use key “←” “→” to select and set PLU EDIT/TARE EDIT/DISCOUNT/SALE MESSAGE(NOTE 1) EDIT/INGREDIENTS (NOTE 2) EDIT/EXTRA MESSAGE (NOTE 3) EDIT/ NOTE 4 EDIT/DEPARTMENT/GROUP/LCD ADVISE EDIT/HEAD EDIT/TAIL EDIT/PRINT PLU LFCODE
 3. AD VALUE: choose this item to check the AD value and then press key can print the AD value.
 4. REPORT: use key “←” “→” to select Promoter report/X group report/Z group report/X PLU report/Z PLU report/Stat. mode/Prn Subtot/Prn all Stat. PLU/Clr Stat/X dept. report/Z dept. report needed.

10.3 Function Lock

PLU edit, discount, tare, system setting and other functions can be locked by password and the password is the same and changeable. Password is set by background PC server and downloaded to every scale.

Operation on the label scale is as followings:

Note: Once you turn on the locked function, this function will be valid until the scale is warmly closed.

Turn on the locked function	1. Turn on the scale.
	2. Select the desired function key. <ol style="list-style-type: none"> 1) Press Discount key to enter discount function, the system prompts to input password, then input the password which is set by background PC server and then press Enter key to confirm. 2) Press PLU key for two second to enter PLU editing state, the system prompts to input password, then input the password which is set by background PC server and then press Enter key to confirm. 3) Press System Set key for two seconds to enter system setting state, the system prompts to input password, then input the password which is set by background PC server and then press Enter key to confirm. 4) Press Tare key to enter tare state, the system prompts to input password, then input the password which is set by background PC server and then press Enter key to confirm. 5) Press Change Price key for one second or two seconds to enter change price state, the system prompts to input password, then input the password which is set by background PC server and then press Enter key to confirm.
Lock functions again.	1. Press On/Off key for two seconds to close the scale.
	2. Press On/Off key to open the scale.

10.4 Lock Scale

You can lock the scale by password, so that other people can't do any operation on the scale. Lock scale as the following method:

Lock the scale	1. Press "5710085".
	1. Press Password key until the word "PASSW" appears on the LCD display.
	2. Input the eight-digit password by numeric keyboard.
	3. Press Password key and after hearing a "beep" sound to show the password has been set.
Turn on the lock casually	1. Turn on the scale.
	2. The LCD display "PASSW".
	3. Input the eight-digit password, then press Password key to turn on the lock.
Turn on the lock timelessly	1. Turn on the scale.
	2. Press C key during the countdown.
	3. Press Password key, the word "PASSW" appears on the LCD display.

4. Input the eight-digit password, then press **Password** key to turn on the lock.

5. Long press **C** key to exit factory mode.

11 COMMUNICATION SETUP

11.1 Wired Ethernet Setup

Barcode scale, Ethernet contains PC and several scales, every scale connect Ethernet via HUB. As follows:

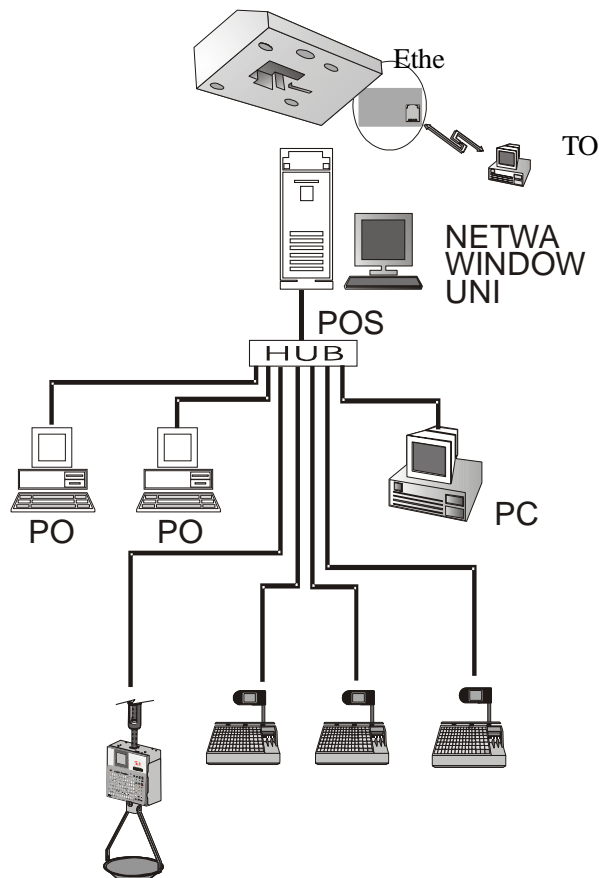

Ethernet IP Address set:

1. The division of the Ethernet IP address is by professional person, and the IP address of workstation is the same as the scales (the first nine digits are the same). Any workstation under the same segment install LINK66 can make communication test to the scales under the same segment.
2. Refers to “System Set”---‘IP Address Input’ downloaded from website to input the IP to the scales.

Communication Line Setup Requirements:

1. Consider the installation of the communication line setup when install label scale. Internet installation had better be done during install local pipeline. Communication line use 8core Ethernet communication cable to make sure the wire rod is under low impedance.
2. The installation of the line should avoid interference source, such as air compressor and high-power electricity appliance, and avoid to install alongside the high current power line, and use metal sheath to shield.
3. The sheath is need to protect the communication line, PVC or metal sheath are available, use metal sheath under strong electromagnetic interference and connect the metal to the floor to shield.

4. The place for barcode scale should be away from humidity environment, junction box should pay attention to damproof.
5. The whole length of the wire should not beyond 100m, use standard A line connect way or B line connect way, one system use one connection method.

11.2 Wireless Ethernet Setup

If you purchase the wireless scale, you can use wireless Ethernet setup method to set up the communication network. Use the transmit and receipt equipment of wireless Ethernet from our company can make the barcode scale connect with wireless Ethernet.



11.3 Making procedure of connector

(1) Select a connector wire (8 pin) by length of L.

(2) Put A end of the connector wire at the edge of blade of pliers horizontally (note: point against the baffle to ensure 12mm peeling length), press the pliers and pull out the wire and the peeling length is about 12mm.

1. Connection order:

green/white, green, orange/white, blue, blue/white
orange, brown/white, white.

2. line Connection order:

orange/white, orange, green/white, blue, blue/white,
green, brown/white, white.

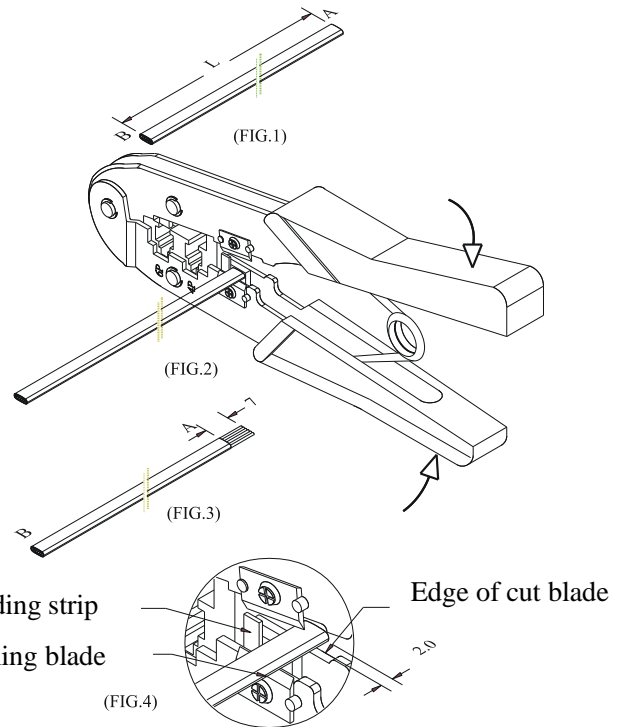

(3) Plug peeling end (A) into 8 PIN PHONE connector as either Connection order above.
Make sure to plug to the end.

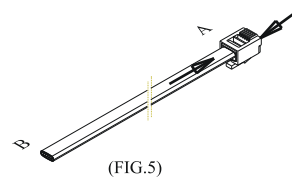

(4) Plug wire connector with 8 pin into the position with logo 8P of pliers gently, then press the pliers forcefully.

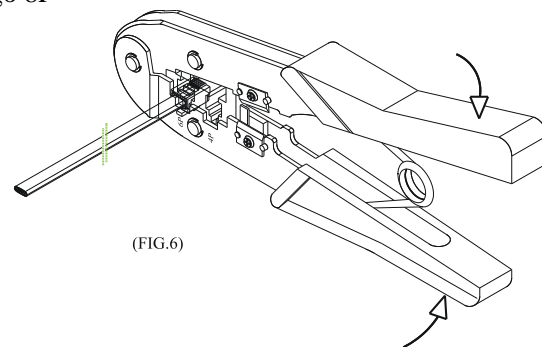

(5) When process end B of connecting wire, don't twist wire and keep the wire with same color in the same position.

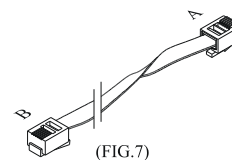

12 Troubleshooting

The scale breaks down:

1. There is no sound and displaying 'UPDATE' when power is on.

Reason: The same as the above.

Treatment: Download POS program to the scale again.

2. Buzzer sounds continuously and the displaying characters bounce.

Reason: The same as the above.

Treatment: The same as the above.

Question about print:

1. Paper location is normal but the printed out label is blank.

Reason: Label type sets error. It is required label type printed out by the scale should be consistent with which downloaded from PC. Otherwise the label printed out will be blank.

Treatment: a. Adjust the scale according to the following sequence.

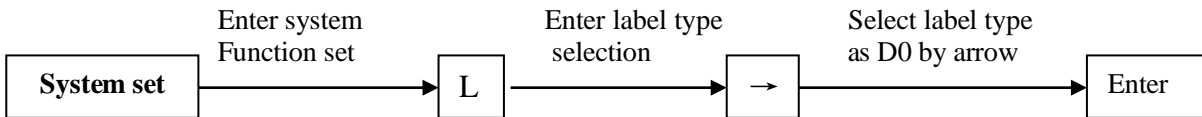

b. Also we can adjust the software with PC. Open LINK66, input serial number of the scale, run command function set and download this function set to the scale.

2. Printer spits out half paper or one and a half papers and paper locates abnormally.

Reason: a. Paper type sensor set error

b. Printer back photoelectric group is in wrong direction or covered by dust.

c. Photoelectric board is bad.

d. Photoelectric group of back photoelectric is bad.

Treatment: a. According to the following sequence, adjust the scale.

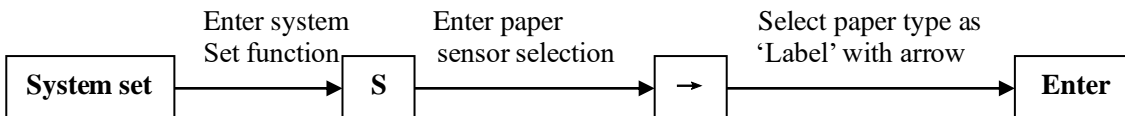

We can also make software adjustment on computer. Open 'LINK66', set paper type as 'Label' in function set; download the set to the scale.

b. Check whether the back photoelectric group is gradient or covered by dust.

c. If it can't be resolved yet it is necessary to exchange back photoelectric group, which had better be handled by the professional of our company.

3. Label out of printer is obscure and not dark enough.

Reason: a. Printer header is not put well.

b. Hot sensor head is dirty.

c. It is necessary to carry on voltage learning.

Treatment: a. Place printer header in suitable position

b. Clean the thermal printer with soft tissue or swab (no hard stuff, like knife), if not clean enough, please clean it with fine dried cloth dipped in little alcohol in shutdown mode.

4. Label printed out is half clear and half blur even blank.

Reason: a. Printer header is not put well.

b. Hot sensor header is dirty.

c. Printer header is distorted.

Treatment: a. Place printer header in suitable position.

b. Clean the thermal printer with soft tissue or swab (no hard stuff, like knife), if not clean enough, please clean it with fine dried cloth dipped in little alcohol in shutdown mode.
(Please refer to the demonstration below.)

c. If this problem can't be resolved yet it is necessary to change the printer. The bad printer had better to be handled by professional of our company.

➤ Demonstration for cleaning the thermal printer head:

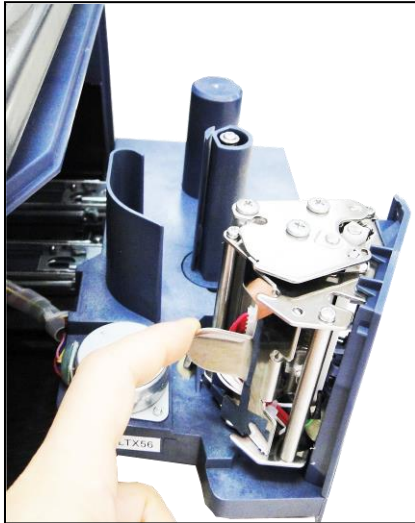

① **Open the thermal printer head**

5. There is strange letter on the label.

Reason: LFZK has not been downloaded.

Treatment: Download LFZK again.

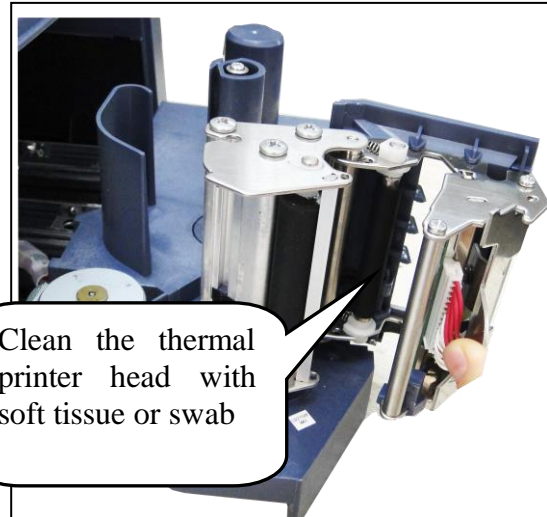

② **Clean the thermal printer head.**

Questions about keyboard:

1. Display is normal but keyboard sounds continuously.

Reason: There is a short circuit in keyboard.

Treatment: change keyboard circuit.

2. Key doesn't sound.

Reason: a. Key wire is not inserted well.

b. Electric rubber of key press circuit board is not installed well.

c. The replaced kit is bad.

Treatment: a. Check key wire and insert it again.

b. Remove the electric rubber of key press and another location with rubber strip install again.

c. If the problem can't be resolved yet, the selected kit is bad.

Questions about weighing:

1. The scale can't weigh correctly.

Reason: a. Rubber pad, which sustains the scale pan, touched the shell (upper cover).

b. Humidity or component aging or area difference makes the scale weigh incorrectly.

c. Sensor is damaged by over loading.

Treatment: a. Check whether the upper covers are buckled well. If they still knock each other, install sensor sustainer again.

b. Study zero weight and full weight again. If it is still no use, change main board, OP board or even the sensor.

c. Change sensor and sustainer.

Note: OP board and sensor should be returned to our company in principal if they can't be used.

2. Zero state is not stable.

Reason: a. It is affected by environment such as vibration, or magnetic field interference, or wind.

b. Weighing circuit is affected with damp.

Treatment: a. Remove interference.

b. Change main board.

c. If the problem can't be resolved. Return the whole scale to our company to repair.

3. The scale can't weigh.

Reason: Main board or OP board or sensor is bad.

Treatment: a. Change main board.

- b. Check whether OP board is abnormal. Return the whole scale to our company.

Questions about communication:

1. The scale can't communicate.

Reason: a. Communication port set error.

- b. Serial number of the scale has not been set.
- c. Connecting head is not used correctly or Netware wire is obstructed.
- d. There is some wrong with power board or main board.

Treatment: a. Confirm the correct communication port.

- b. Confirm number set in LINK66 is consistent with the number in the scale.
- c. Confirm the Netware wire is smooth and communication connecting header is used correctly. There are two types of communication port RS-232 which uses 9-pin or 25-pin connecting port attached with the scale and RS-422 which uses RST-11A connecting head.
- d. If the above are right, detect whether main board or power board is wrong and change the wrong main board or power board.

2. Downloading is stopped at 1/N (n represents some number) and computer shows message "communicate error!"

Reason: Main board is error, which may be caused by chip damage.

Treatment: Change main board or chip (ROM).

Question about display:

Display can't show all characters or even a character.

Reason: a. Display pole has not been installed well, which causes the display and the machine in bad contact.

- b. Water flows into the base seat of display pole which makes link board short-circuit or rotten.
- c. Display is damaged.

Treatment: a. Install display pole and fix the bolt.

- b. Change link board or display pole.
- c. Change display pole.

Other question:

Roll paper can't be driven by print.

Reason: maybe roll paper doesn't get well along with rotating axis. Or there is some matter with rotating axis.

Reason: Maybe roll paper doesn't get well along with rotating axis. Or there is some matter with rotating axis.

Treatment: Install the printer again which had better be processed by our company.

13 APPENDIX

13.1 Appendix 1: Barcode Coding List

Barcode type	Department	Commodity number	Total price	Weight	Checksum
00~09: Ean13 code, the front two codes represent department code:					
00	DD (2)	IIIIIIII (10)	X	X	C
01	DD (2)	IIIII (6)	PPPP (4)	X	C
02	DD (2)	IIIII (5)	PPPPP (5)	X	C
03	DD (2)	IIII (4)	PPPPPP (6)	X	C
04	DD (2)	III (3)	PPPPPPP (7)	X	C
05	DD (2)	IIIII (6)	X	Q.QQQ (4)	C
06	DD (2)	IIIII (6)	X	QQ.QQ (4)	C
07	DD (2)	IIIII (5)	X	QQ.QQQ (5)	C
08	DD (2)	IIIII (5)	X	QQQQ.Q (5)	C
09	DD (2)	IIIII (5)	X	QQQQQ (5)	C
10~19: Ean13code, the front two codes represent fixed code:					
10	20(2)	IIIIIIII (10)	X	X	C
11	21(2)	IIIII (6)	PPPP (4)	X	C

12	22(2)	IIIII (5)	PPPPP (5)	X	C
13	23(2)	IIII (4)	PPPPPP (6)	X	C
14	24(2)	III (3)	PPPPPPP (7)	X	C
15	25(2)	IIIII (6)	X	Q.QQQ (4)	C
16	26(2)	IIIII (6)	X	QQ.QQ (4)	C
17	27(2)	IIIII (5)	X	QQ.QQQ (5)	C
18	28(2)	IIIII (5)	X	QQQQ.Q (5)	C
19	29(2)	IIIII (5)	X	QQQQQ (5)	C

20: no print barcode

21~29: Ean13 code, the front one code represents department code:

21	D (1)	IIIII (7)	PPPP (4)	X	C
22	D (1)	IIIII (6)	PPPPP (5)	X	C
23	D (1)	IIIII (5)	PPPPPP (6)	X	C
24	D (1)	IIII (4)	PPPPPPP (7)	X	C
25	D (1)	IIIII (7)	X	Q.QQQ (4)	C
26	D (1)	IIIII (7)	X	QQ.QQ (4)	C
27	D (1)	IIIII (6)	X	QQ.QQQ (5)	C
28	D (1)	IIIII (6)	X	QQQQ.Q (5)	C
29	D (1)	IIIII (6)	X	QQQQQ (5)	C

30~35,40~45: 18code, the front one code represents department code

30&33	D (1)	IIIII (6)	PPPPP (5)	QQ.QQQ (5)	C
31&34	D (1)	IIIII (6)	PPPPP (5)	QQQQ.Q (5)	C
32&35	D (1)	IIIII (6)	PPPPP (5)	QQQQQ (5)	C

Barcode type	Department	Commodity number	Price	Weight	Checksum
--------------	------------	------------------	-------	--------	----------

40~45: Ean18 code, the front one code represents department code

40&43	D(1)	IIIII(6)	UUUUU(5)	WW. WWW(5)	C
41&44	D(1)	IIIII(6)	UUUUU (5)	WWWW.W(5)	C
42&45	D(1)	IIIII(6)	UUUUU (5)	WWWWW(5)	C

50~52: 8 code

50	X	IIIII (7)	X	X	C
51	D (1)	IIIII (6)	X	X	C
52	DD (2)	IIII (5)	X	X	C
53	X	IIIII(8)	X	X	X
54	D(1)	IIIII(7)	X	X	X
55	DD(2)	IIIII(6)	X	X	X

Bar code type	Department	Art. No	Quantity/weight	Total/Unit price	Check sum
---------------	------------	---------	-----------------	------------------	-----------

79~85, 87: 18 code

79	DD	IIIII(6)	WW.WWW	PPPPP	X
80	D	IIIII(6)	WW.WWW	PPPPP	C
81	D	IIIII(6)	WWWW.W	PPPPP	C
82	D	IIIII(6)	WWWWW	PPPPP	C
83	D	IIIII(6)	WW.WWW	UUU.UU	C
84	D	IIIII(6)	WWWW.W	UUU.UU	C
85	D	IIIII(6)	WWWWW	UUU.UU	C
87	DD	IIIII(5)	WW.WWW	PPPPP	C

Bar code type	Department	Art. No	Total price	Quantity/weight	Unit price	Check sum
90~95: 18 code, the former two codes print department code						
90	DD(2)	IIIII(6)		WW.WWW	UU.UU(4)	C
91	DD(2)	IIIII(6)		WWWW.W	UU.UU(4)	C
92	DD(2)	IIIII(6)		WWWWW	UU.UU(4)	C
93	D(1)	IIIII(6)	PPPPP(5)		UUU.UU(5)	C
94	DD(2)	IIII(5)	PPPPP(5)	WW.WWW		C
95	DD(2)	IIIII(6)		WWWWW	UU.UU(4)	C
Bar code type	Department	Art. No	Quantity/weight	Total price	Unit price	Check sum
96	DD(2)	IIIII(6)	WWWW	PPPPP(5)		C
Bar code type	Department	Art. No	Total price	Quantity/weight	Unit price	Check sum
97	DD(2)	IIII(4)	PPPPP(6)	WW.WWW		C
Bar code type	Department	Art. No	Quantity/weight	Total price	Unit price	Check sum
98	DD(2)	IIII(5)	UUUUU(5)	WW.WWW		C

Meaning of characters in the above list:

C: CHECKSUM D: Department code 2: Fixed number I: commodity number L: Live code

P: price R: discount Q: weight X: no this item

Notes:

- Ean 13= DEPARTMENT+CODE+[TOTAL PRICE]+[WEIGHT]+C
Items with [] mean no this item in some coding system.
- Usually Ean13 adopts 2 or 22 as its price barcode type while 7 or 77 as its weight barcode type.
- CHECKSUM is calculated by the scale automatically and it is not necessary for user to input in PLU manager.
- The difference between 30-32 and 33-35 is the method to calculate checksum.
- The difference between 40-45 and 30-35 is that the price in 30-35 is total price while in 40-45 is unit price.
- 36-38 is barcode type, which can be accessed by live batch management. Commodity batch number takes up commodity number column and commodity number takes up live code column.